

PLANTA

PERFIL CENTRO DEL TANQUE DE SEDIMENTACION PRIMARIA DETALLE - 3

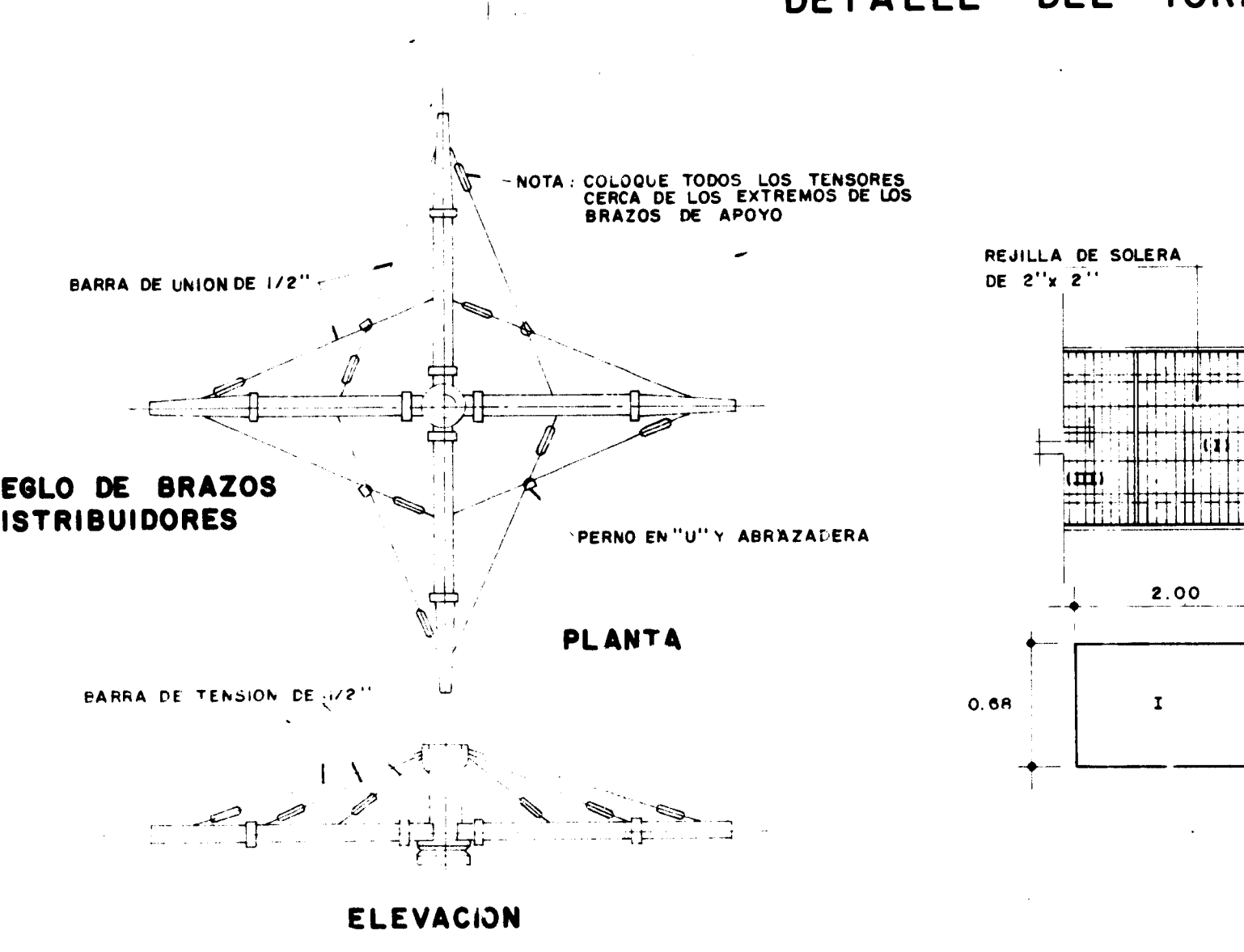

ARREGLO DE BRAZOS DISTRIBUIDORES

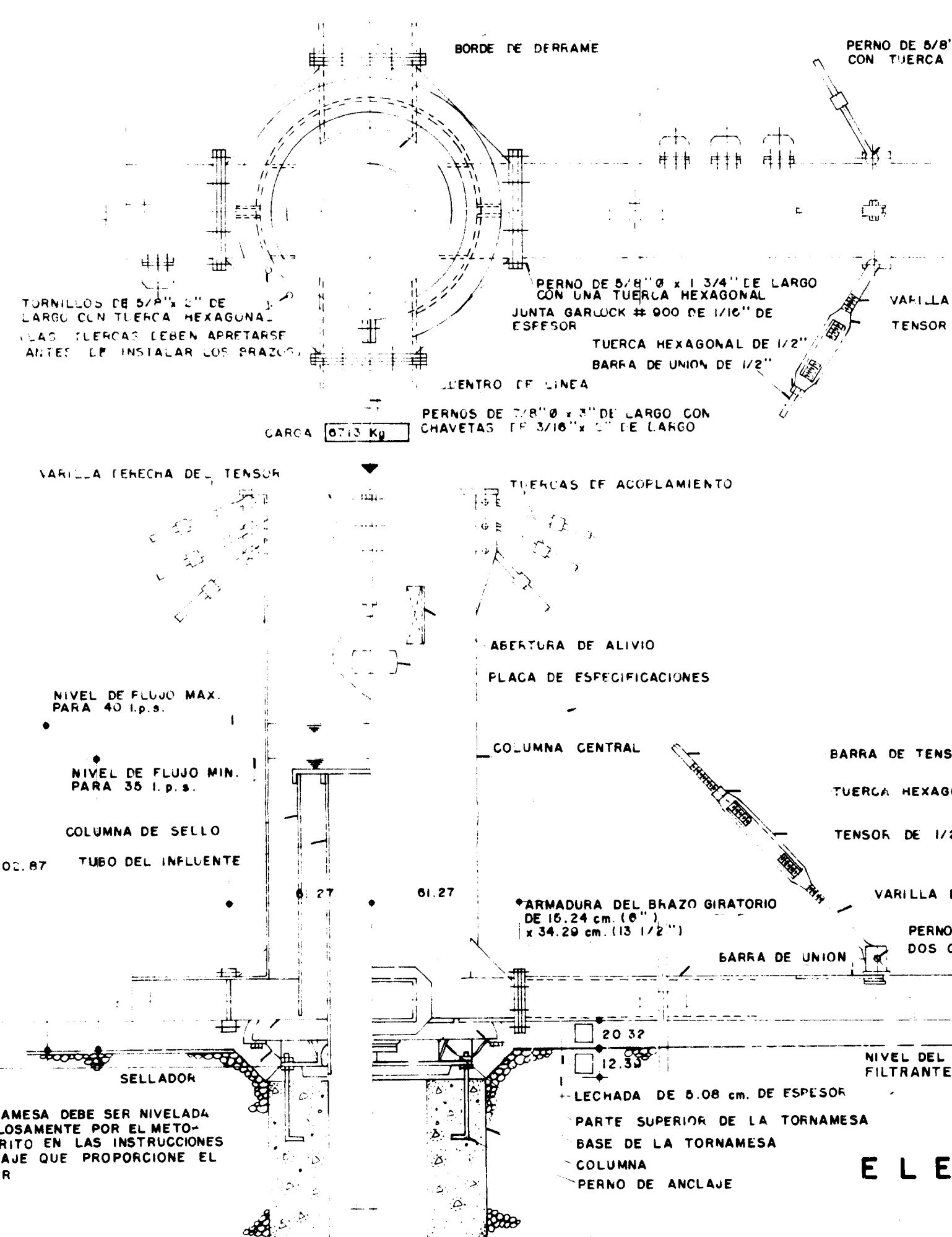
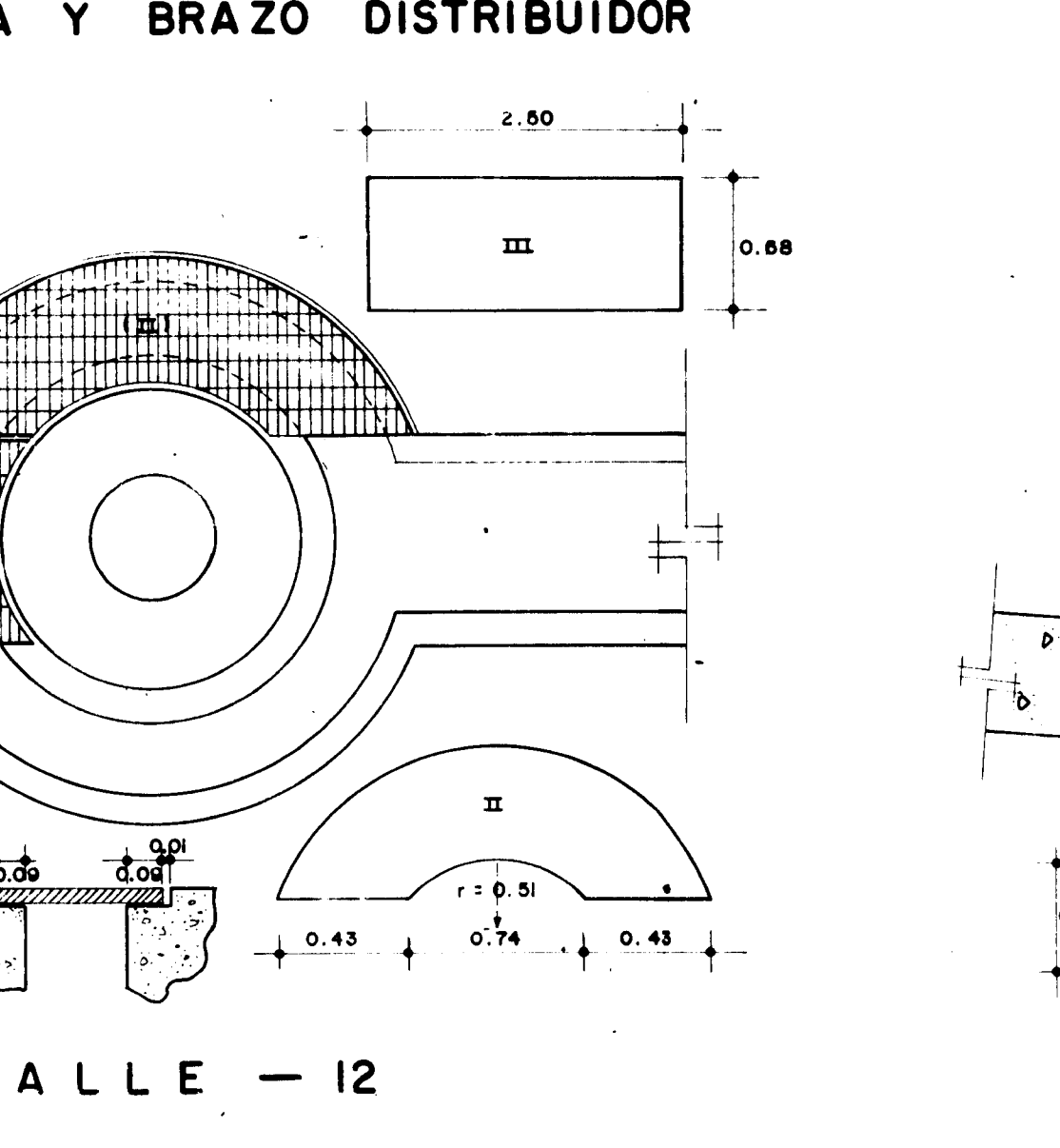
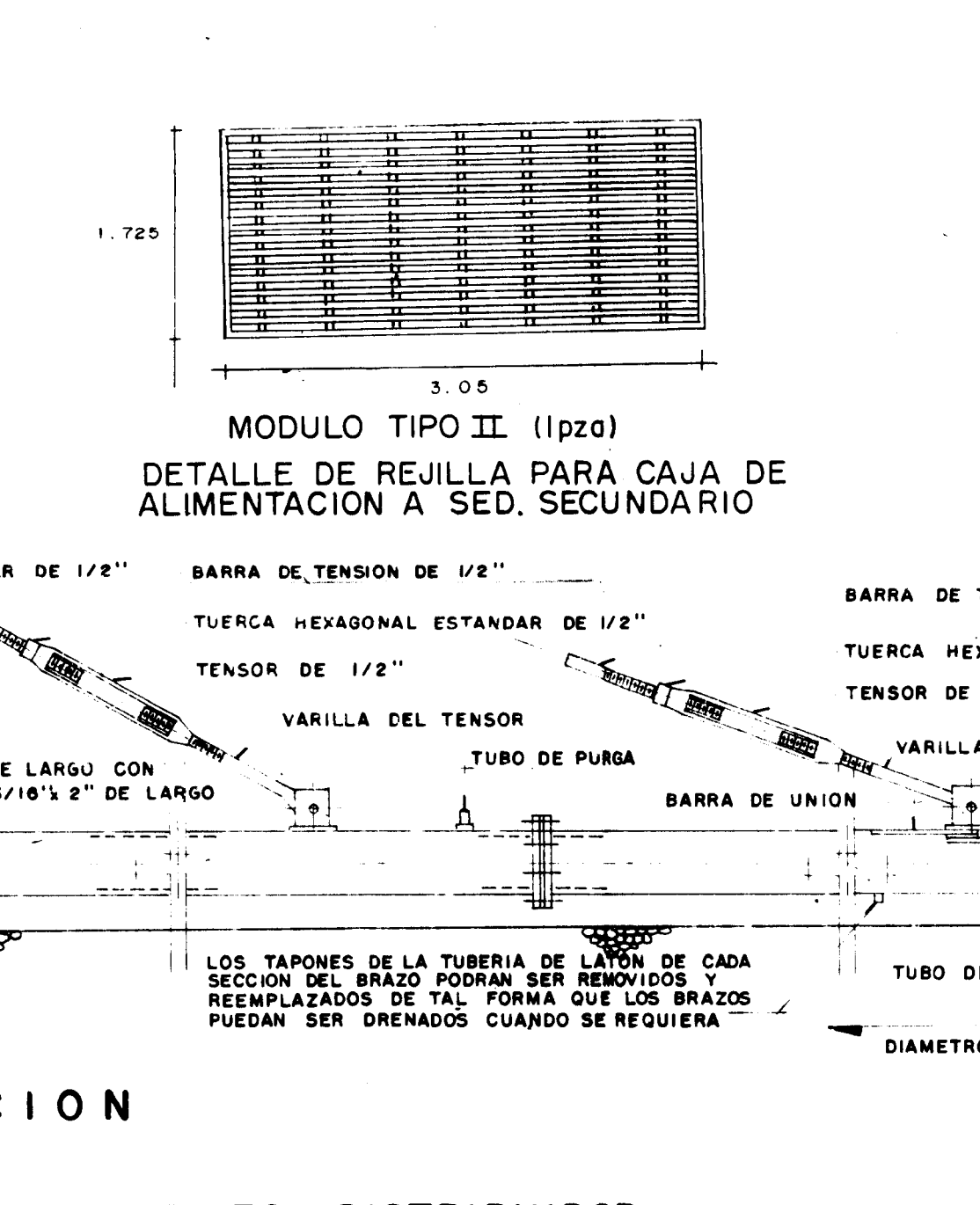
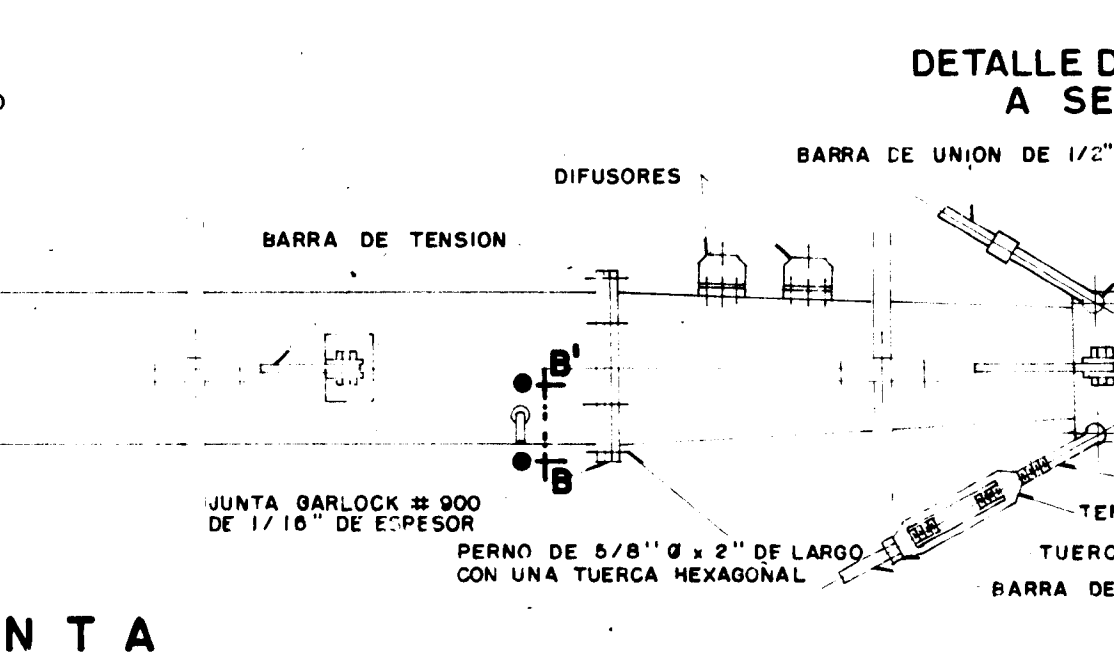
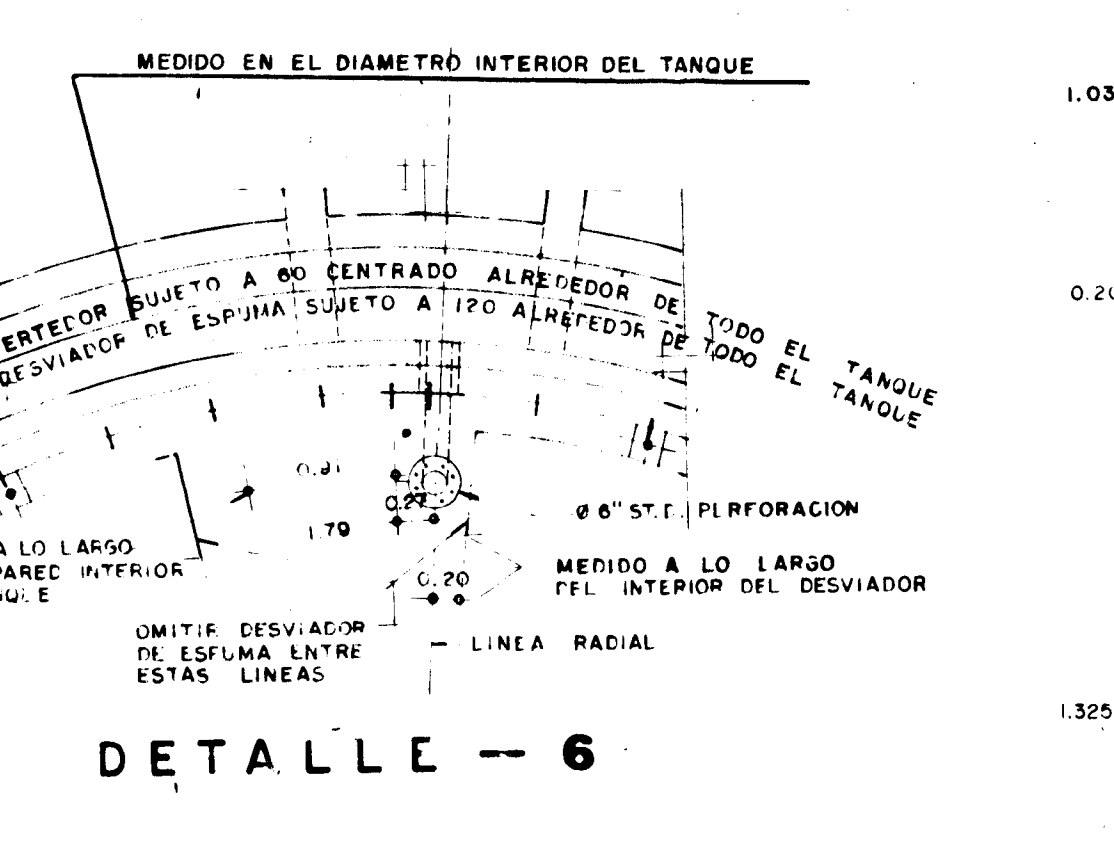
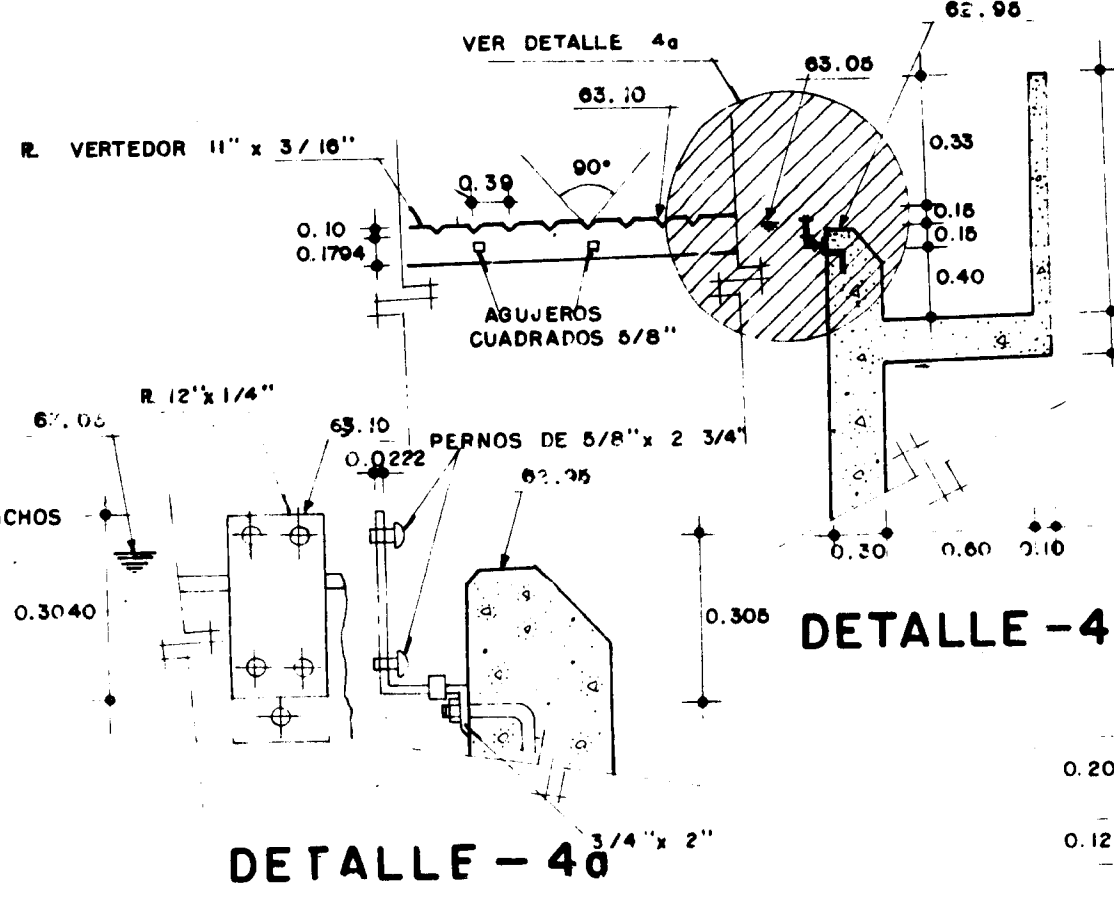

DETALLE - 12

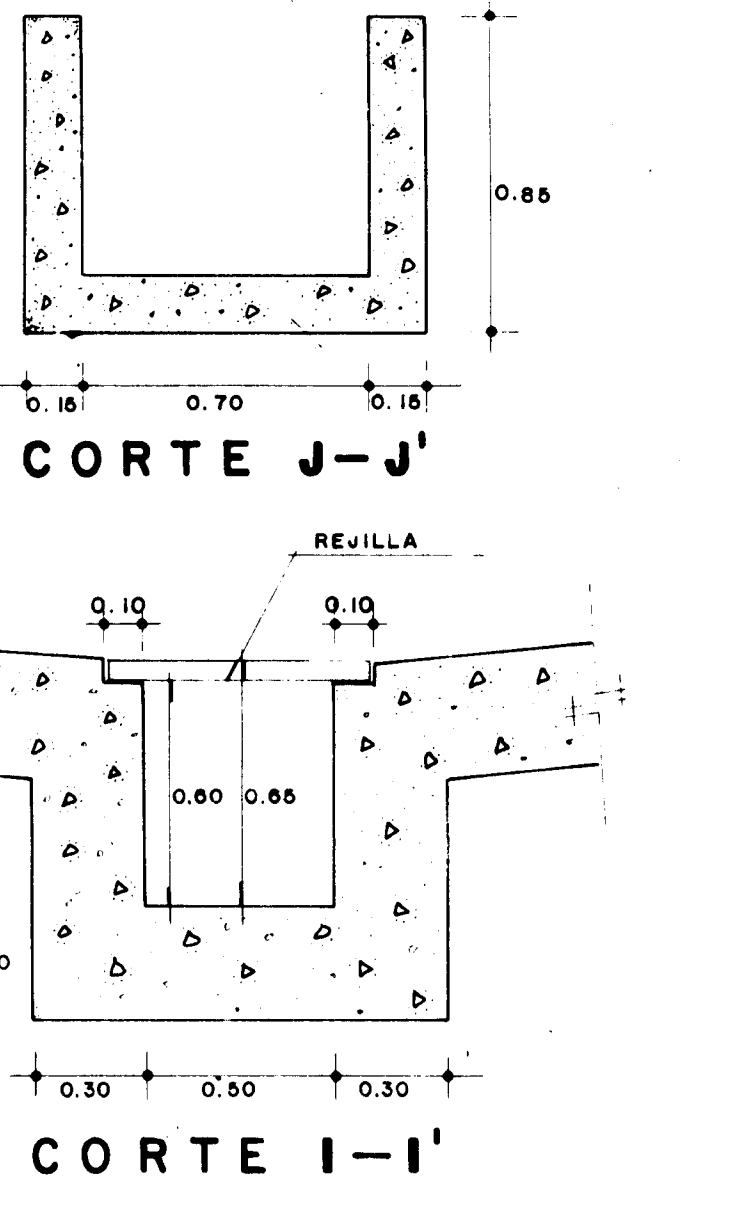
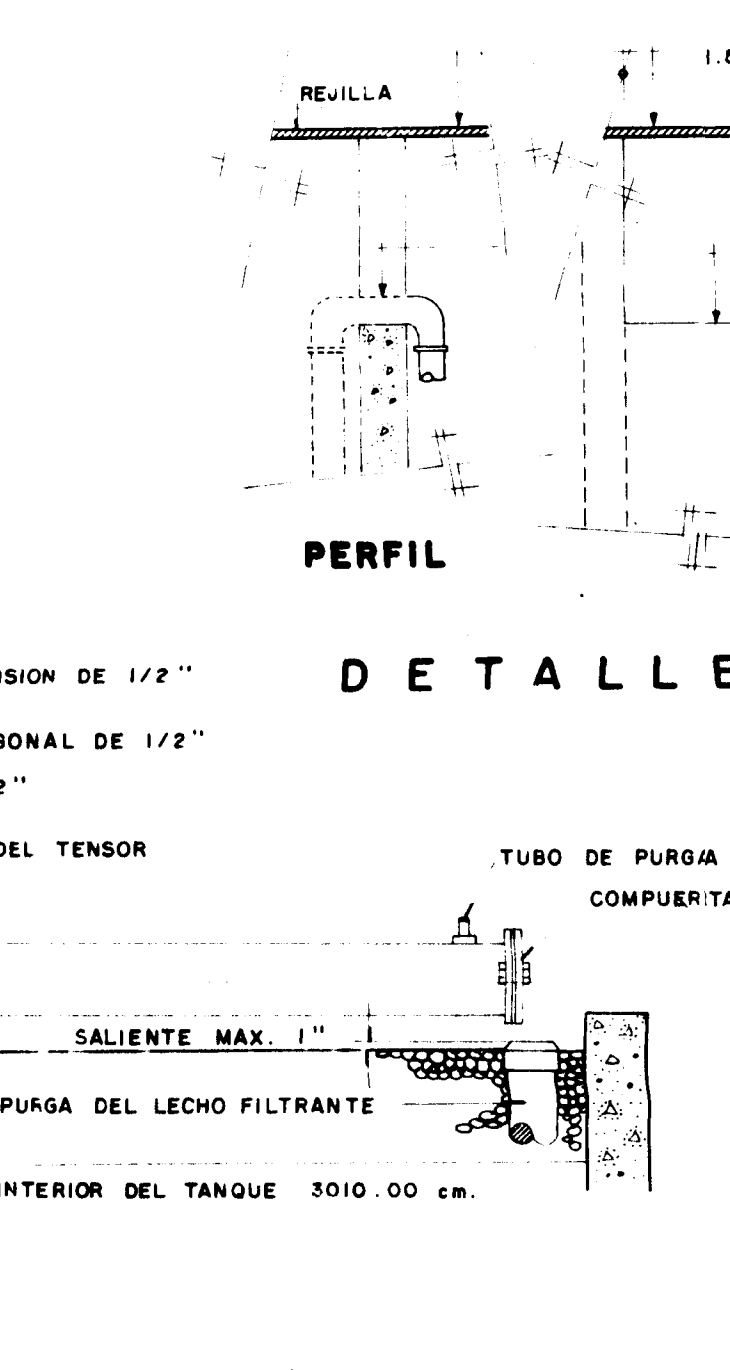
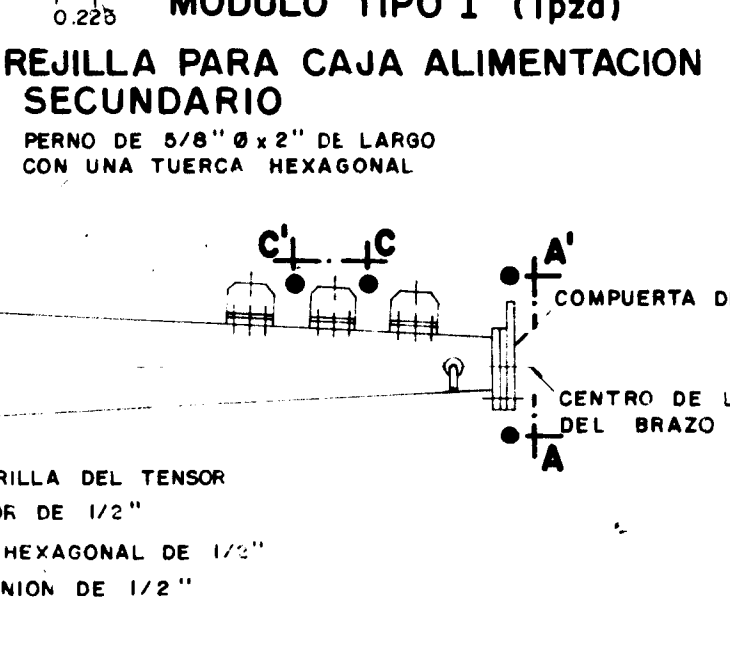
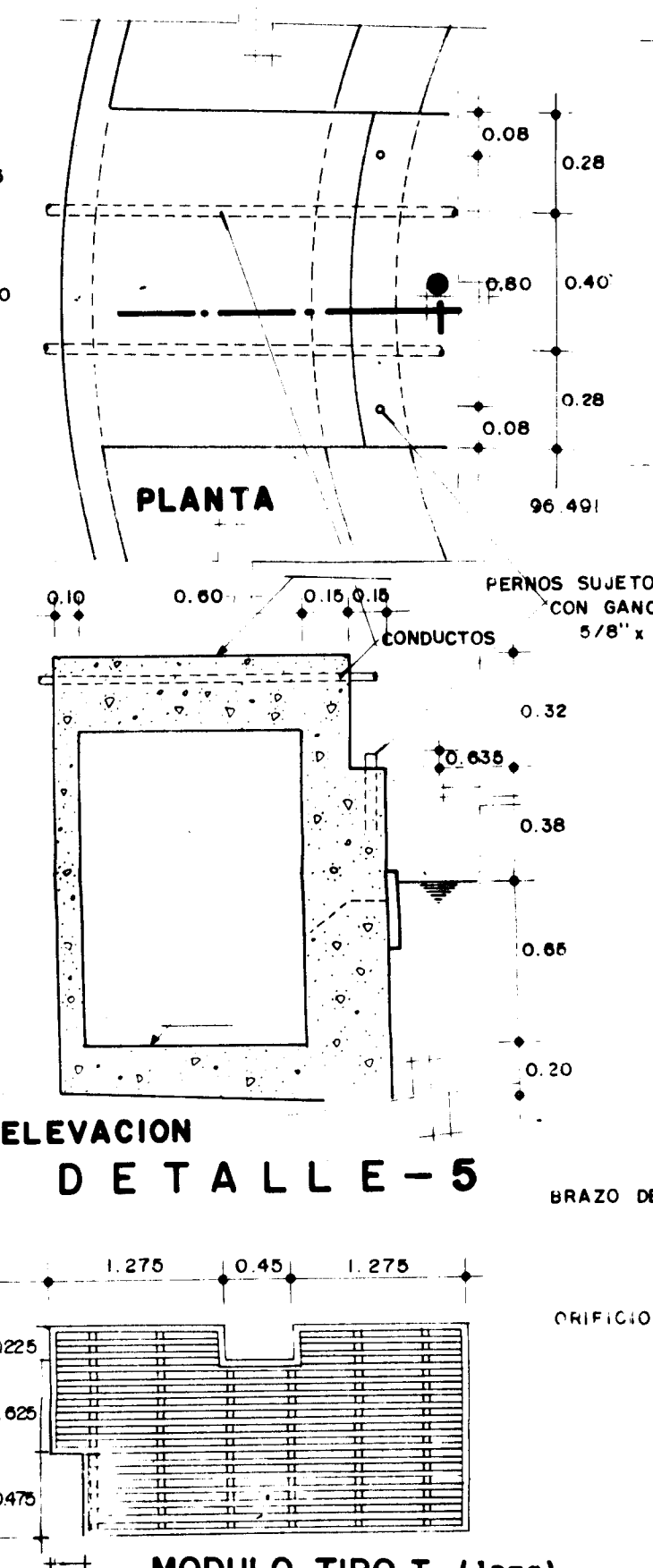

CORTE J-J' and CORTE I-I'

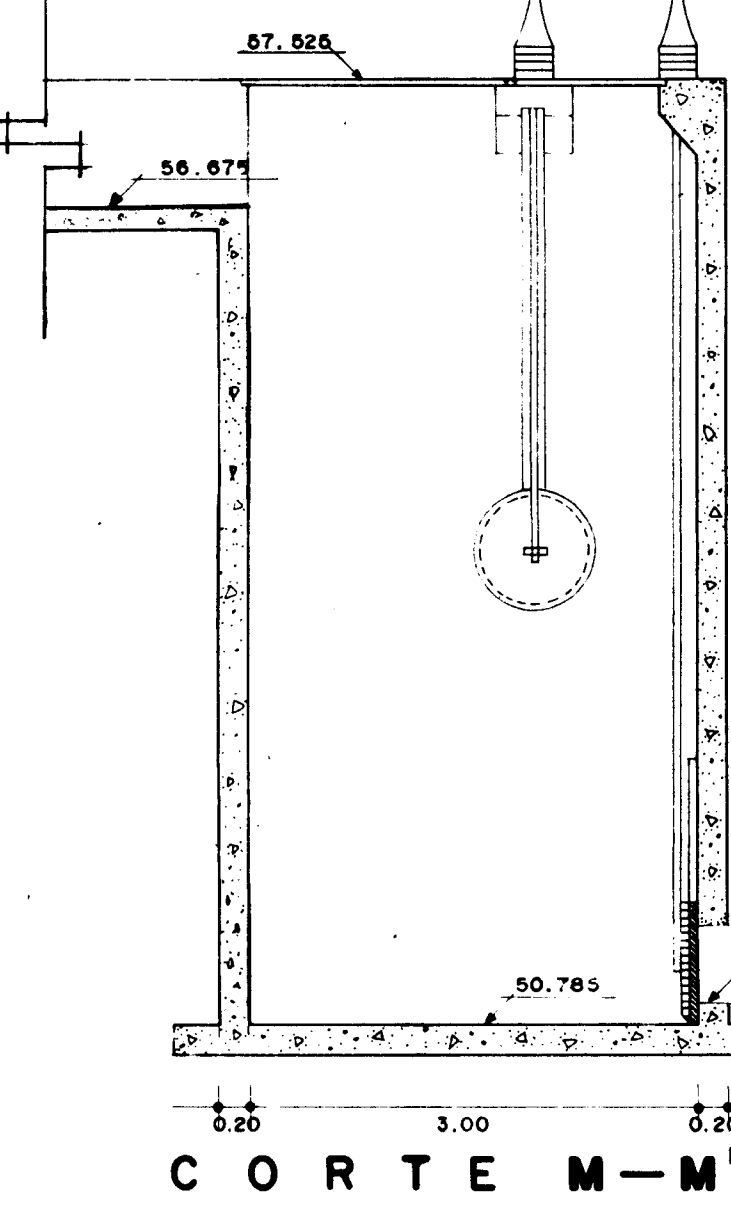
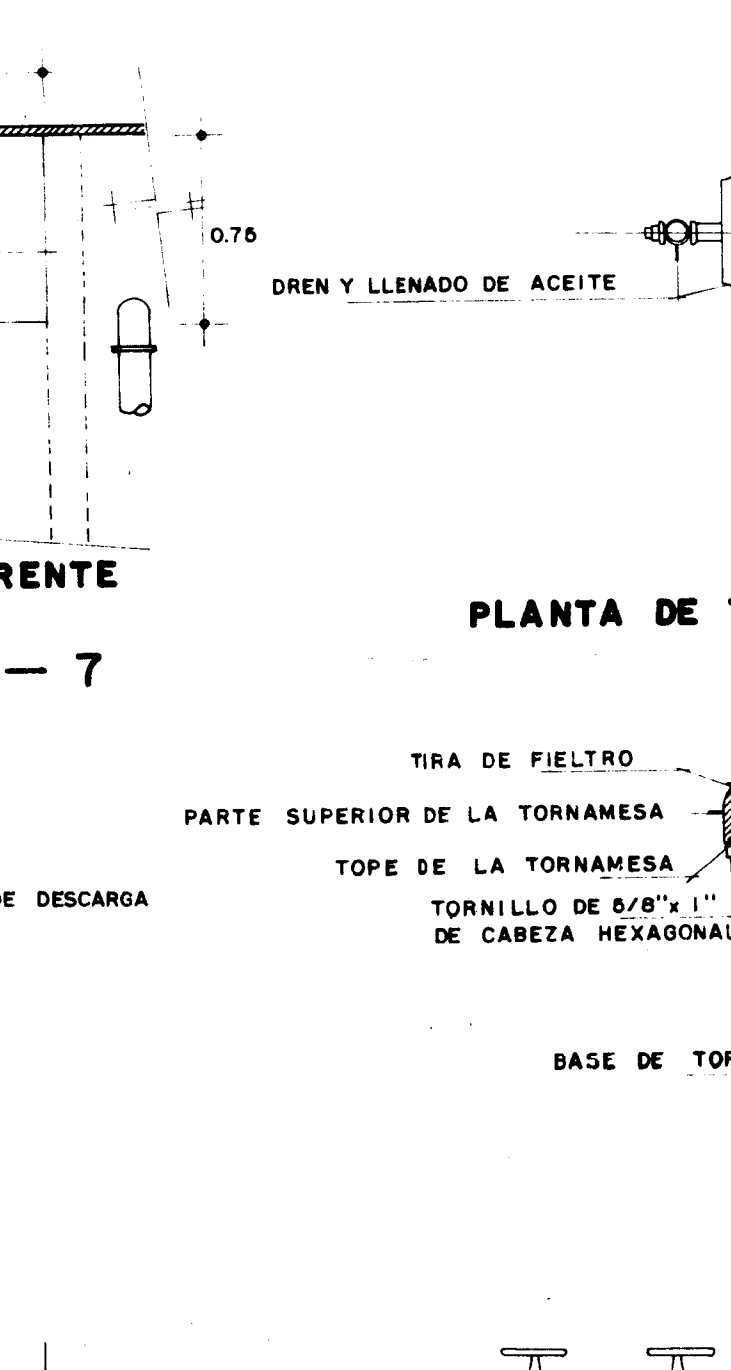
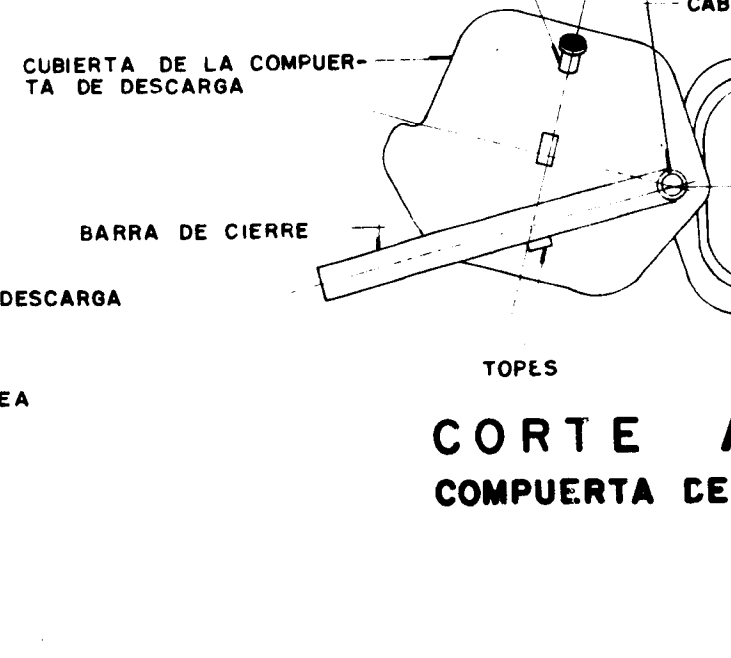
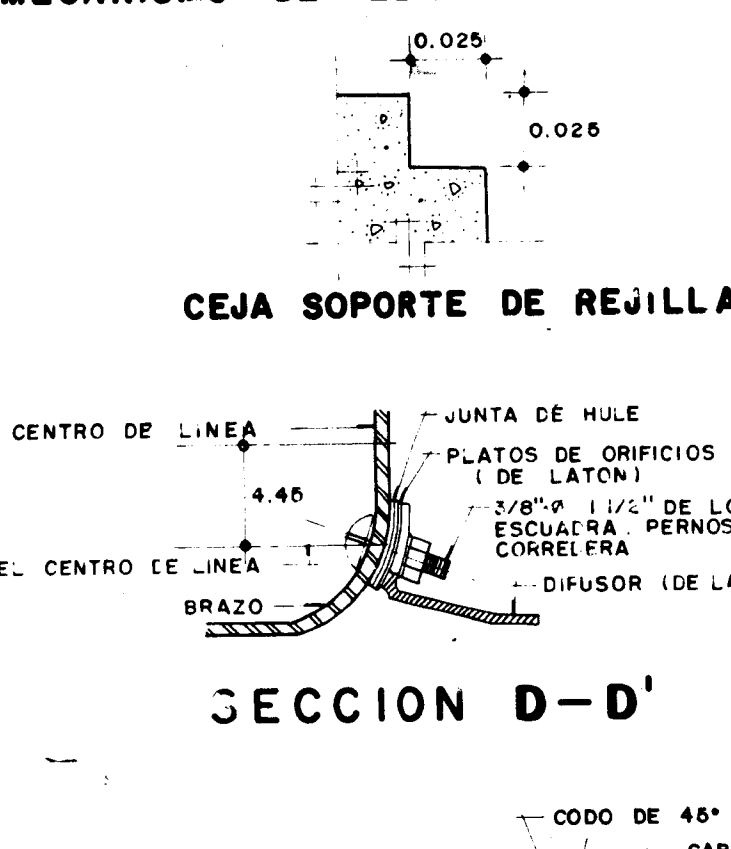
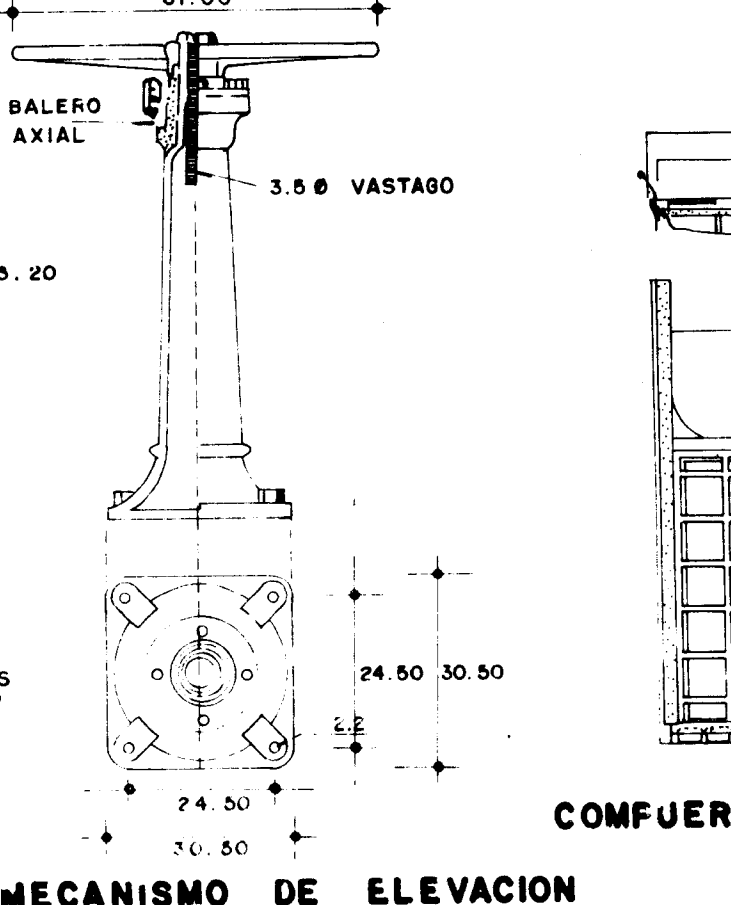

CORTE M-M'

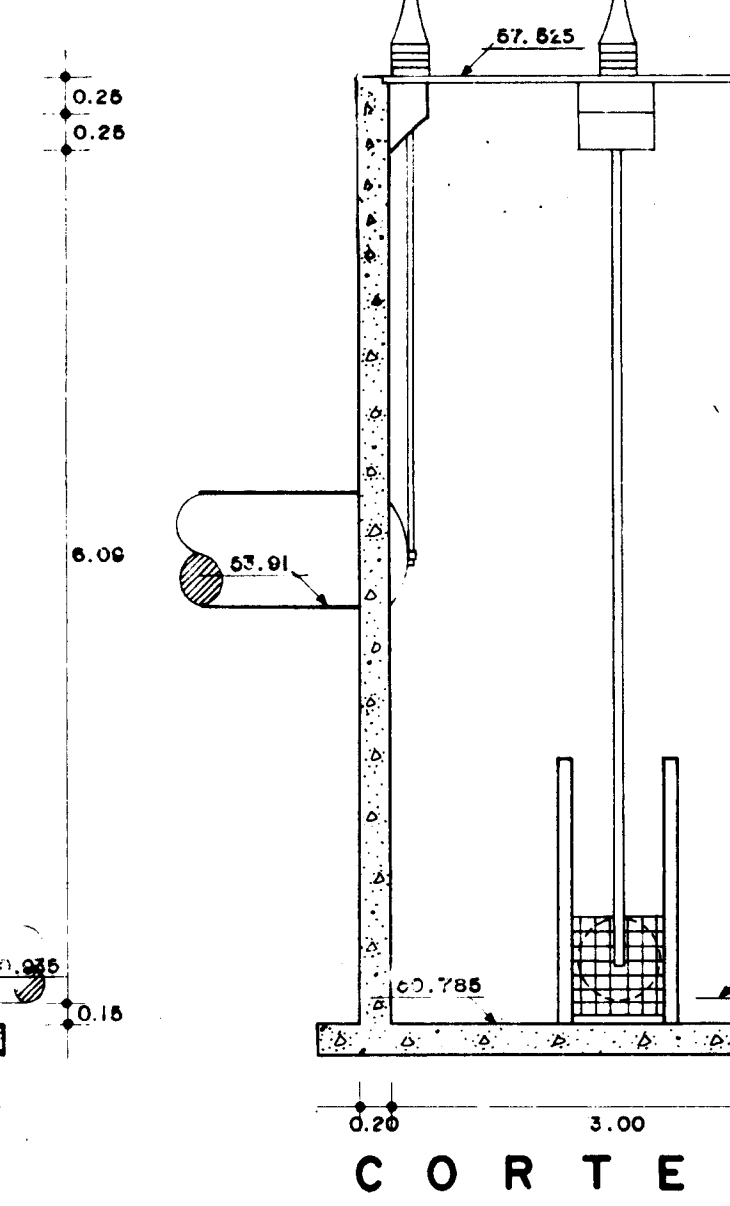
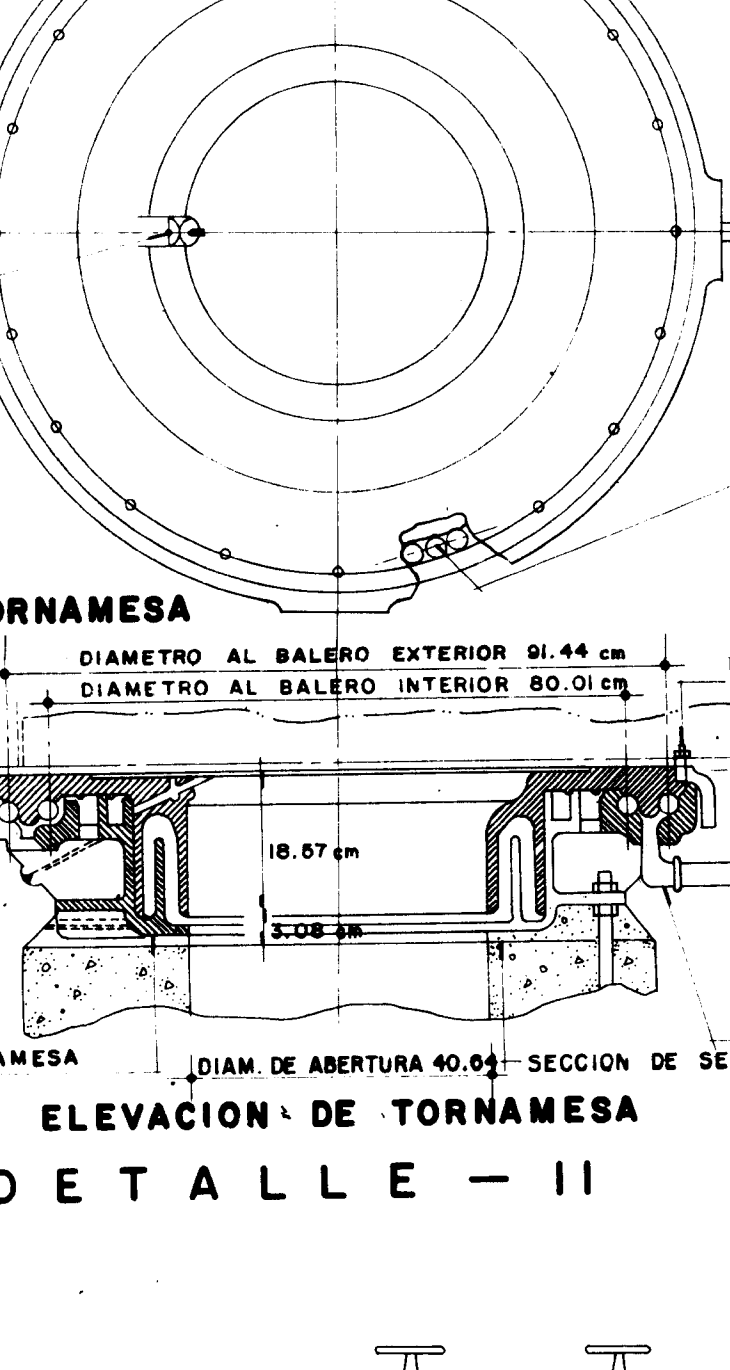
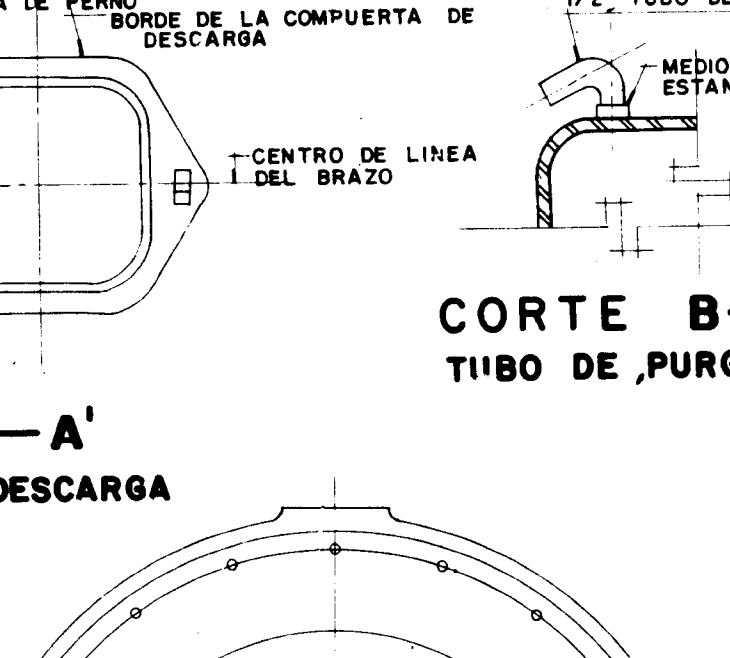
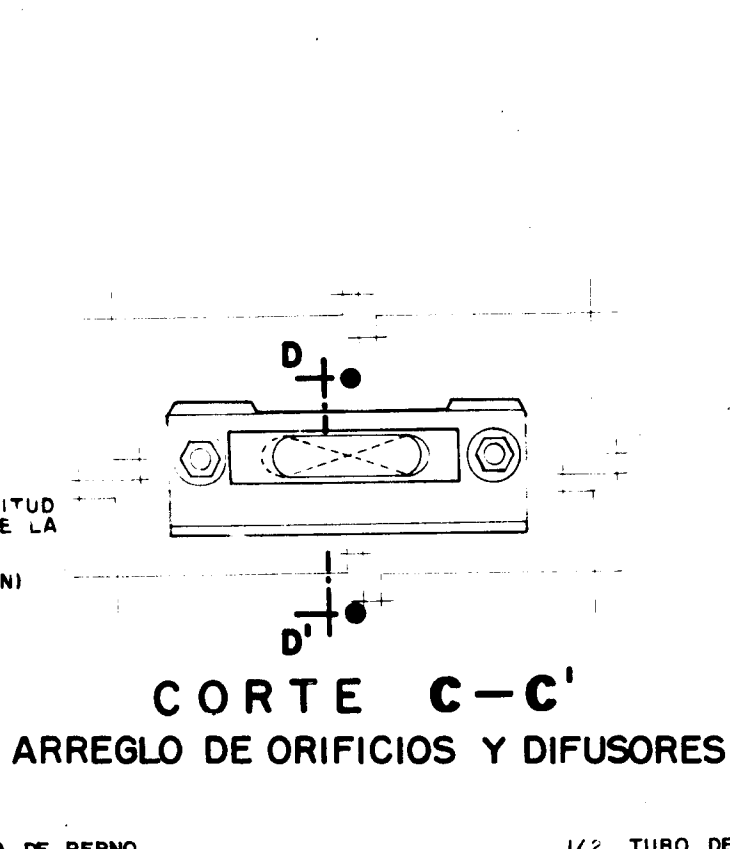
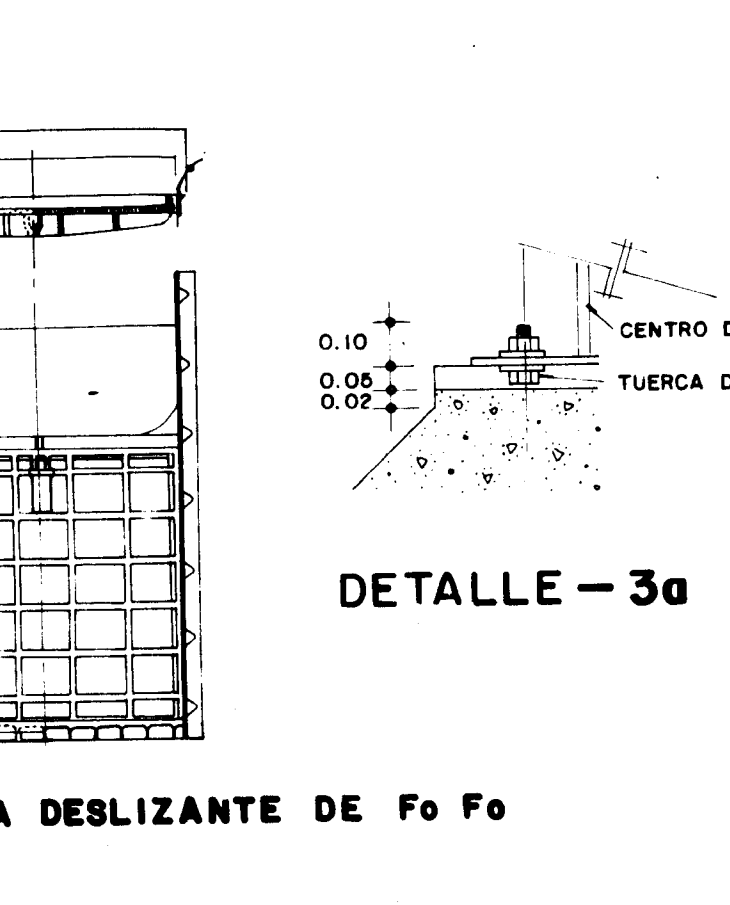

ELEVACION DE TORNAMESA

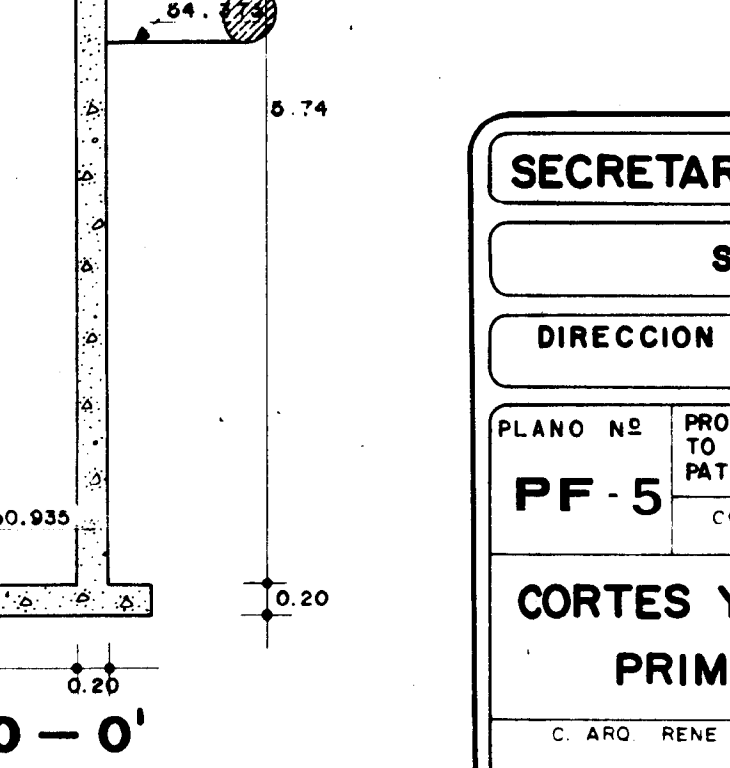
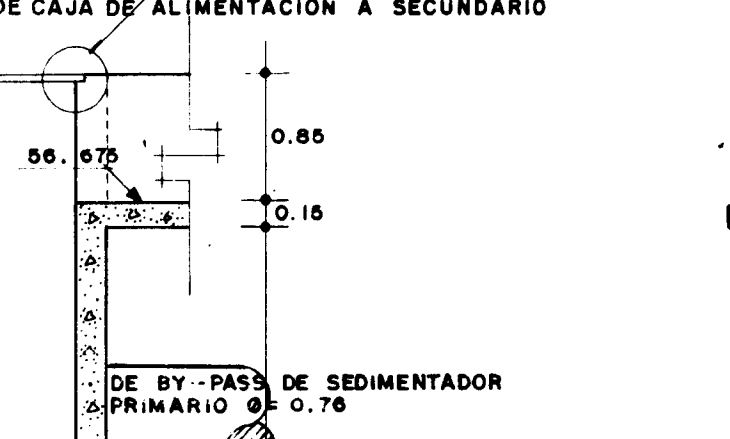
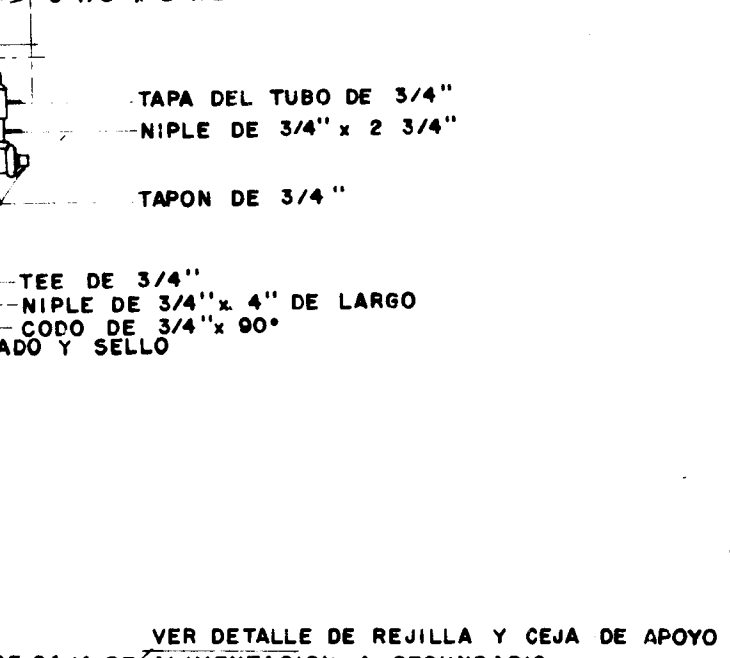
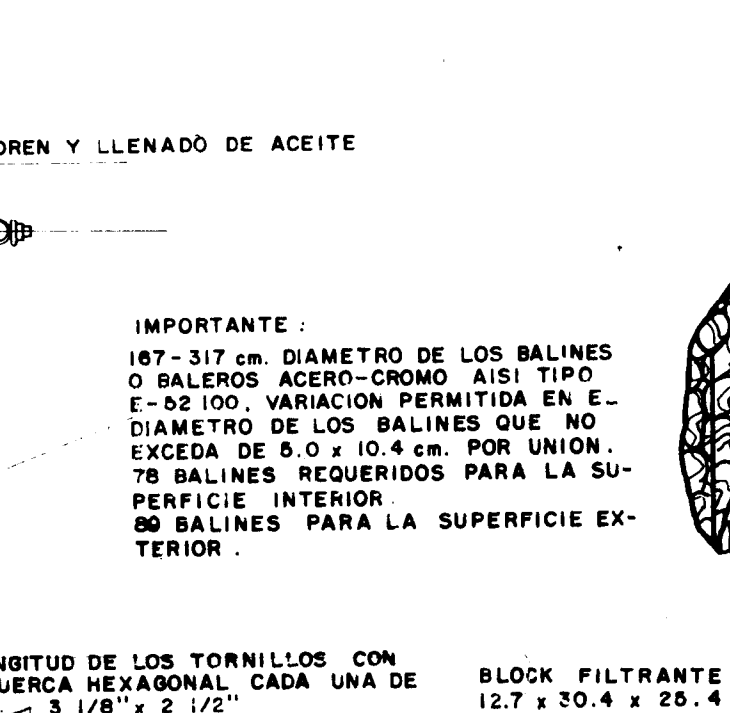
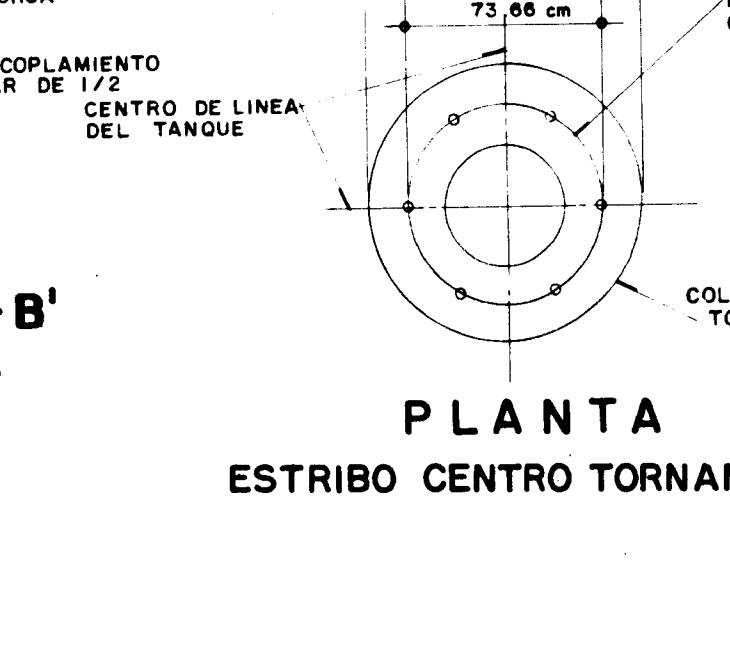
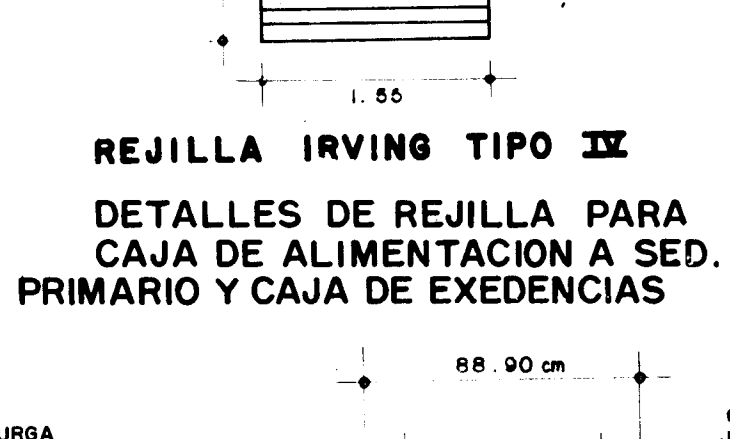
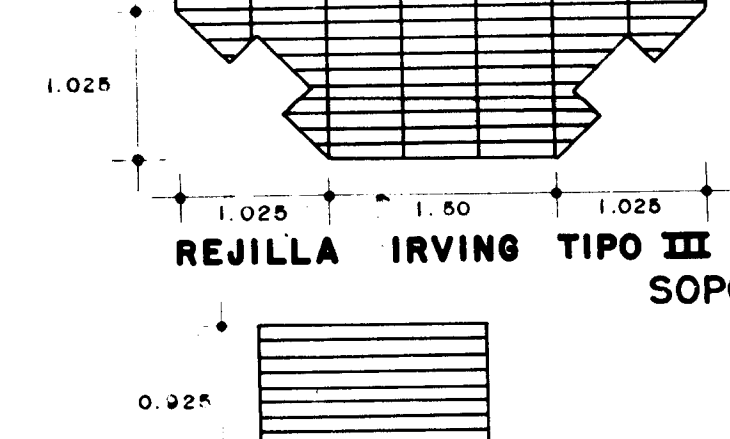
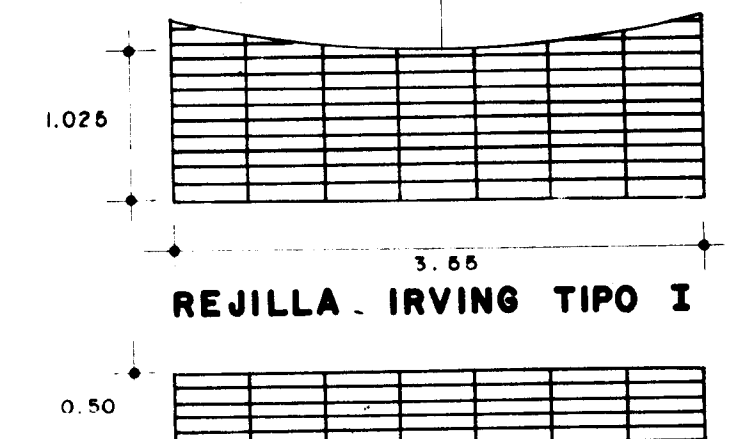
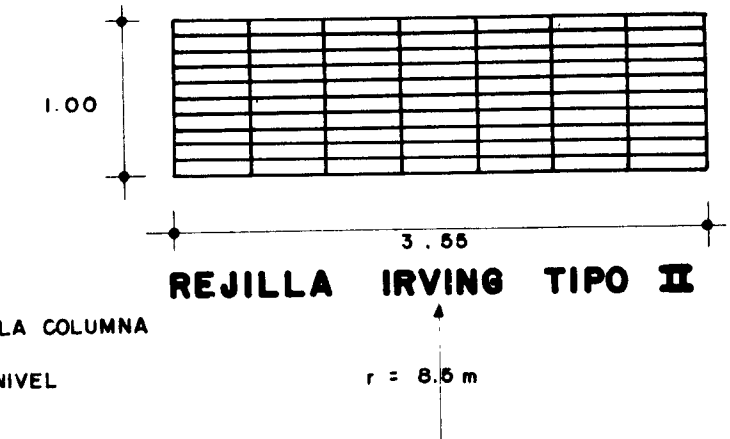

CORTE O-O'

UNIDAD	COMPUERTA (MODELO)	MECANISMO DE ELEVACION (MODELO)	LONGITUD DEL VASTAGO (m)
CAJA DISTRIBUIDORA A FILTROS BIOLÓGICOS	CPT-105	MP-118	6.76
CAJA DISTRIBUIDORA A SEDIMENTADOR SECUNDARIO	MILLER CPT-105	MP-118	6.24

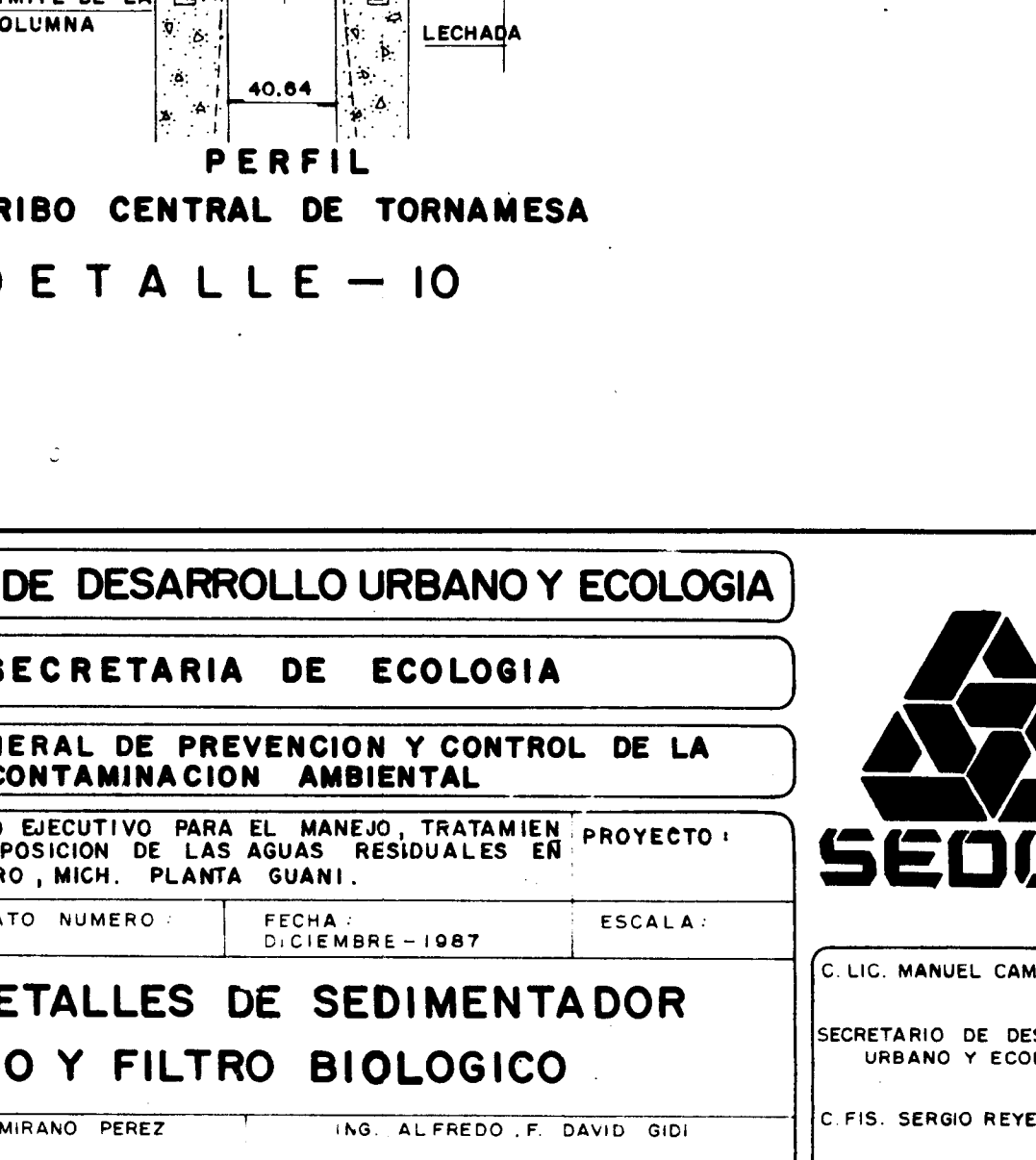
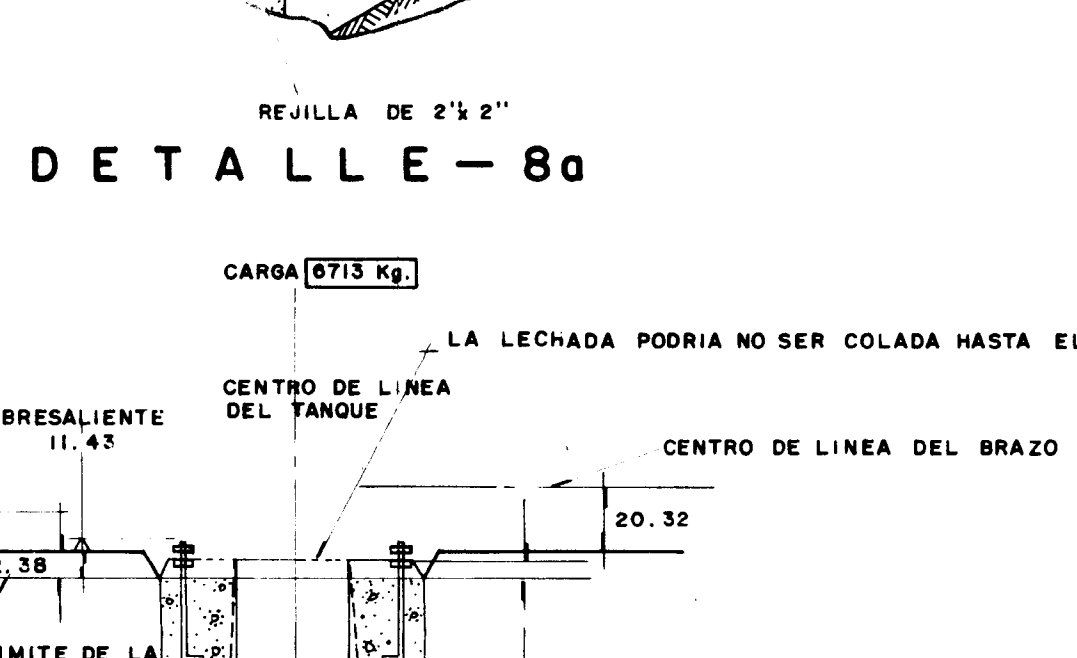
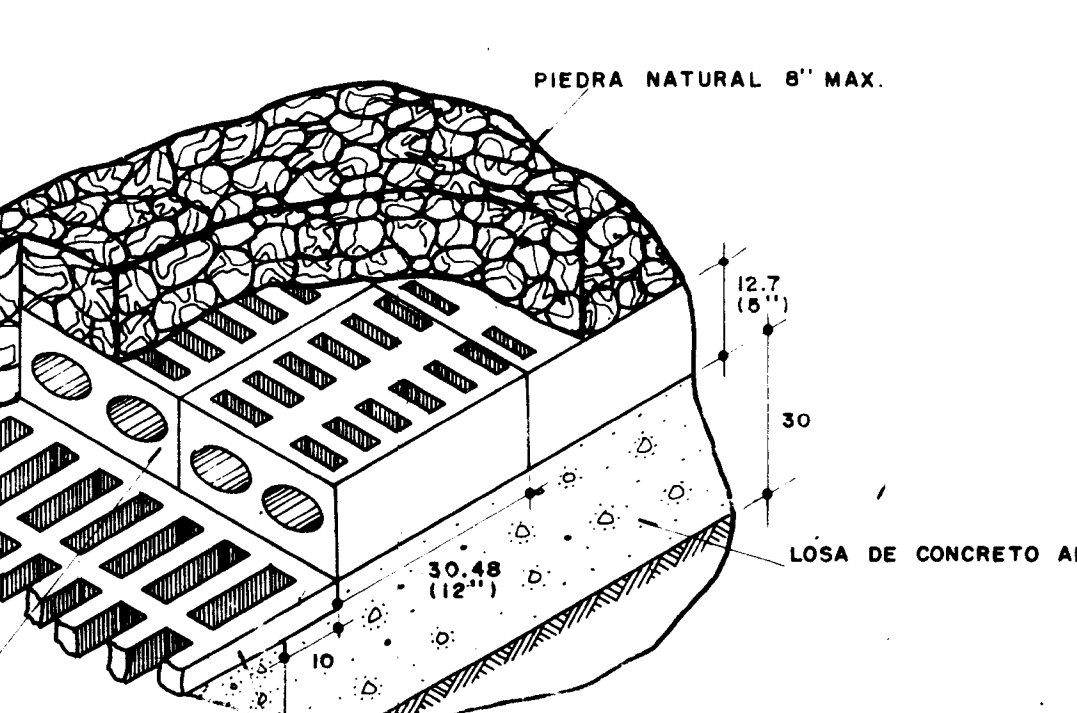
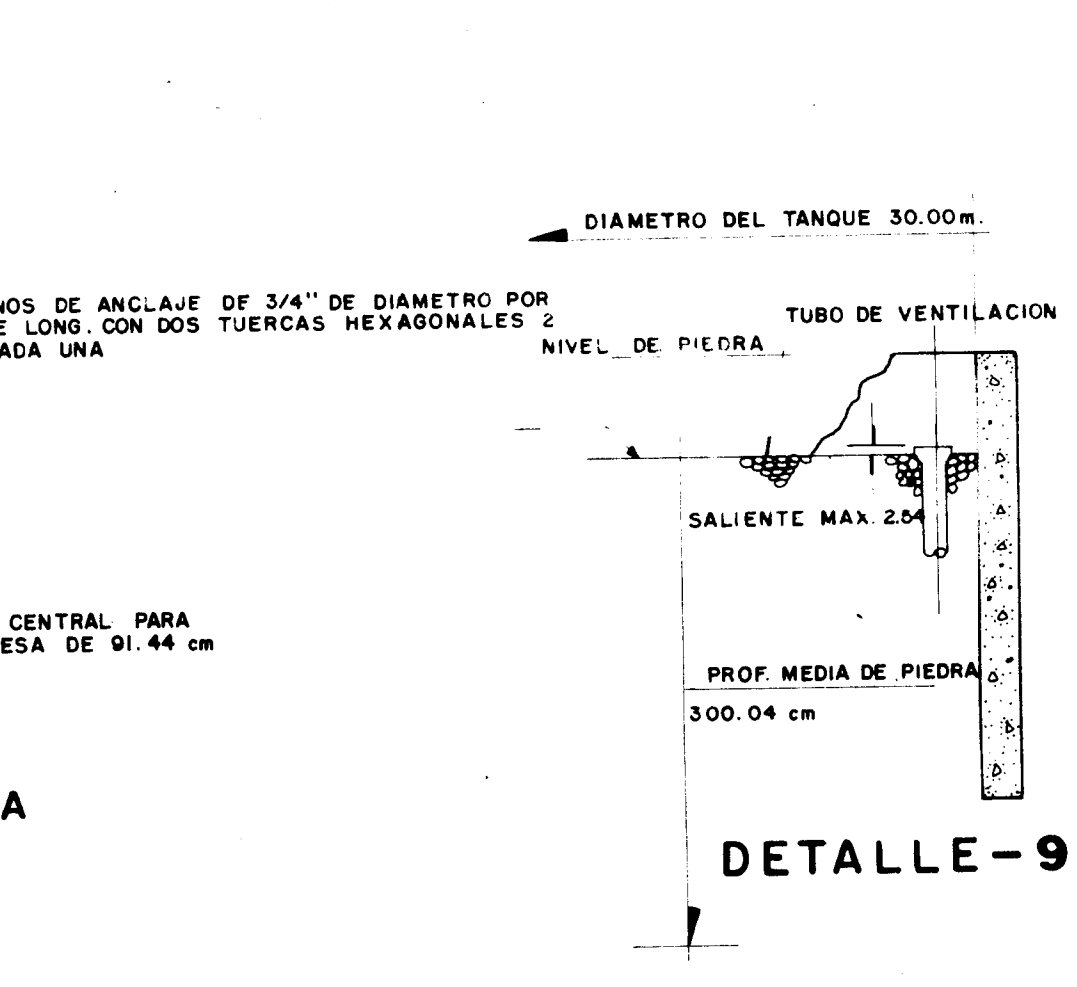
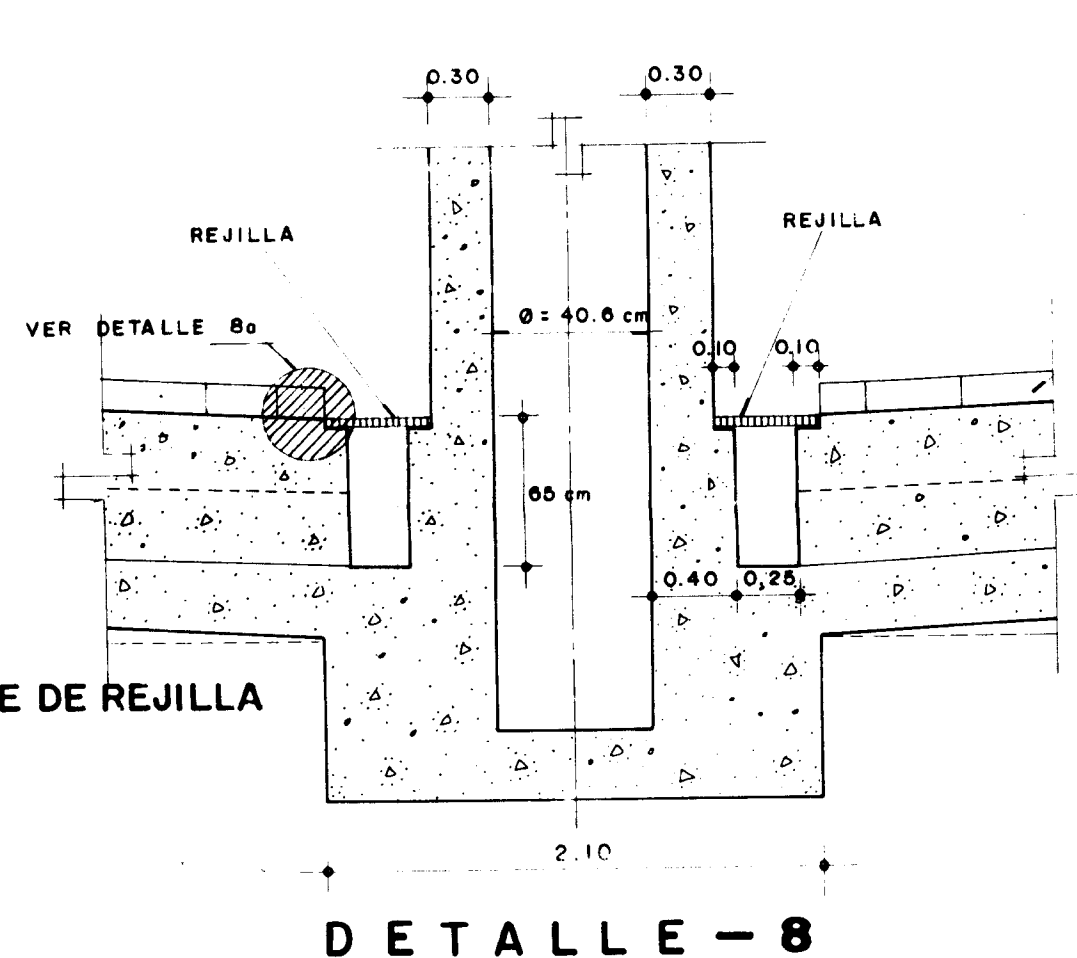

DETALLE - 10

SECRETARIA DE DESARROLLO URBANO Y ECOLOGIA

SUBSECRETARIA DE ECOLOGIA

DIRECCION GENERAL DE PREVENCIÓN Y CONTROL DE LA CONTAMINACION AMBIENTAL

PLANO N° PROYECTO EJECUTIVO PARA EL MANEJO, TRATAMIENTO Y DISPOSICION DE LAS AGUAS RESIDUALES EN PRIZCUARO, MICH., PLANTA SUANI.

PF-5

CONTRATO NUMERO: FECHA: DICIEMBRE-1987

ESCALA:

CORTES Y DETALLES DE SEDIMENTADOR PRIMARIO Y FILTRO BIOLÓGICO

C. LIC. MANUEL CAMACHO S. SECRETARIO DE DESARROLLO URBANO Y ECOLOGIA

C. FIS. SERGIO REYES LUJAN SUBSECRETARIO DE ECOLOGIA

